Installation and Service Guide

Publication number E3493-97001
December 1997

For Safety information, Warranties, and Regulatory information, see the pages behind the index.

© Copyright Hewlett-Packard Company 1994, 1997
All Rights Reserved

HP E3493B Pentium Pro Processor Probe

HP E3493B Pentium Pro Processor Probe—At a Glance

The HP E3493B Pentium Pro processor probe provides a low-cost way to debug embedded software for Intel Pentium® Pro microprocessors.

The target connection

The HP E3493B Pentium Pro processor probe connects to your target microprocessor via a debug port connector (defined by Intel) on the target system.

The HP 16505A connection

The HP E3493B Pentium Pro processor probe connects to the HP 16505A prototype analyzer via an Ethernet LAN for remote operation, or directly for point-to-point operation. The logic analyzer connects to the HP 16505A through a SCSI connector.

The configuration switches

Use the switches to configure communication to the HP 16505A. There is a guide to these switches on the bottom of the processor probe.

The status LEDs

LEDs show the status of the power supply, the target system, and the connection to the HP 16505A.

Additional equipment required

The HP E3493B Pentium Pro processor probe requires the HP 16505A prototype analyzer.

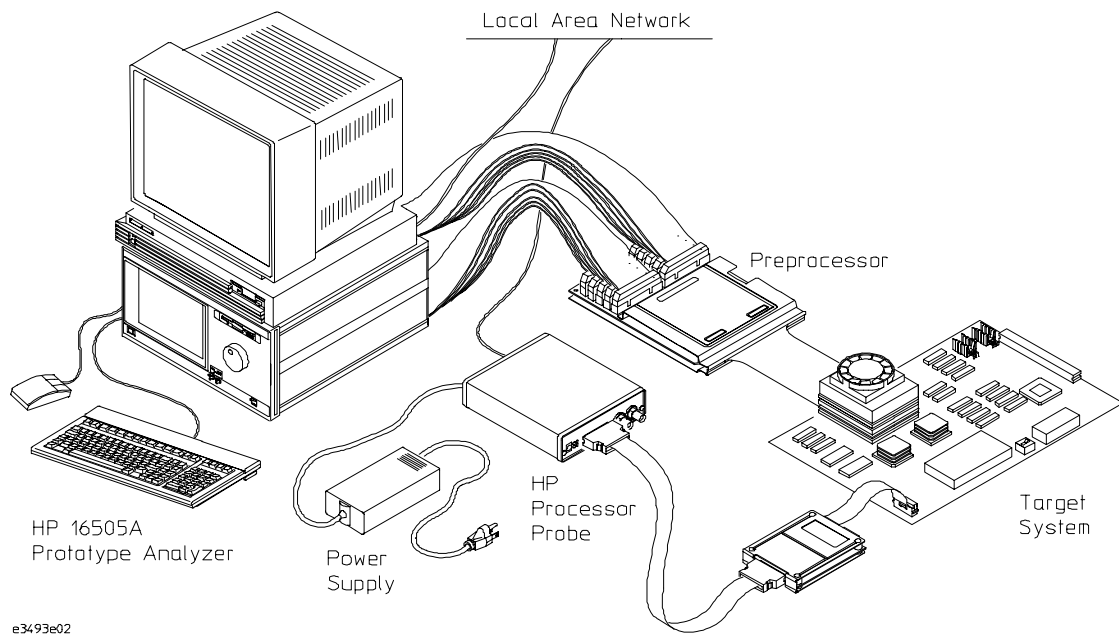

1 Connecting to the HP 16505A Prototype Analyzer 7

Connecting the HP E3493B Pentium Pro Processor Probe to a
Power Source 9

To choose a power cord 9

To connect the power cord and turn on the processor probe 10

Connecting the Probe to the Prototype Analyzer 11

Connecting for a point-to-point configuration 12

Point-to-point Connection 12

Connecting to a LAN 13

LAN Connection 13

To set the 10BASE-T configuration switches 14

Setting Up LAN Communication 15

To set the LAN address of the processor probe 15

To verify LAN communications 16

Setting Up a Serial Connection 17

To set the serial configuration switches 18

To connect a serial cable 18

To verify serial communications 19

To configure LAN parameters using the built-in terminal interface 20

2 Connecting to the Target System 23

- Designing a target system test access port 24
- To test the HP E3493B Pentium Pro processor probe 25
- To connect to a target system via the debug port 25

3 Configuring the Processor Probe 27

- To configure using the Run Control tool 29
- To configure using the built-in terminal interface 30
- To configure the JTAG scan chain 30

4 Specifications and Characteristics 33

- Processor Compatibility 34
- Electrical Specifications 34
- Environmental Specifications 36

5 Solving Problems 37

Status Lights 40

Problems with the LAN Interface 41

- If you cannot verify LAN communication 41
- If you have LAN connection problems 42
- If the "POL" LED is lit 43
- If it takes a long time to connect to the network 43

Problems with the Serial Interface 44

- If you cannot verify RS-232 communication 44

If you have RS-232 connection problems with the MS Windows Terminal program 44

Problems with the HP E3493B Pentium Pro Processor Probe Itself 46

To run the power up self test 46

To execute the built-in performance verification tests 48

Returning the HP E3493B Pentium Pro Processor Probe to Hewlett-Packard for Service 53

To return the HP E3493B Pentium Pro processor probe to Hewlett-Packard 53

To obtain replacement parts 54

Connecting to the HP 16505A Prototype Analyzer

Connecting to the HP 16505A Prototype Analyzer

To use the HP E3493B Pentium Pro processor probe you need to:

- Install the HP E3493B software (Run Control Tool) in the HP 16505A Prototype Analyzer
- Connect the HP E3493B Pentium Pro processor probe to a power source
- Connect the HP E3493B Pentium Pro processor probe to the HP 16505A via a LAN or direct connection
- Connect the HP E3493B Pentium Pro processor probe to the target system (described in the next chapter)

For a list of the parts supplied with the HP E3493B Pentium Pro processor probe, see page 54.

Connecting the HP E3493B Pentium Pro Processor Probe to a Power Source

The HP E3493B Pentium Pro processor probe does not have an On/Off switch. To turn the HP E3493B Pentium Pro processor probe on or off, plug or unplug it from the power supply.

To choose a power cord

The HP E3493B Pentium Pro processor probe is shipped from the factory with a power supply and cord appropriate for your country. If the cord you received is not appropriate for your electrical power outlet type, contact your Hewlett-Packard sales and service office.

Warning

Use only the supplied HP power supply and cord.
Failure to use the proper power supply could result in electric shock.

Caution

Use only the supplied HP power supply and cord.
Failure to use the proper power supply could result in equipment damage.

To connect the power cord and turn on the HP E3493B processor probe

1 Connect the power cord to the power supply and to a socket outlet.

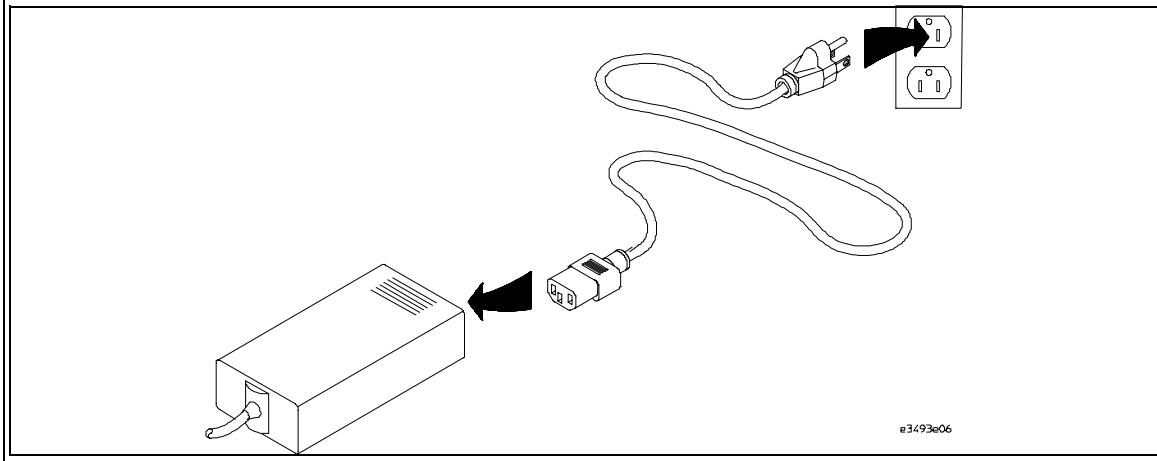

2 Connect the 5V power cord to the back of the HP processor probe.

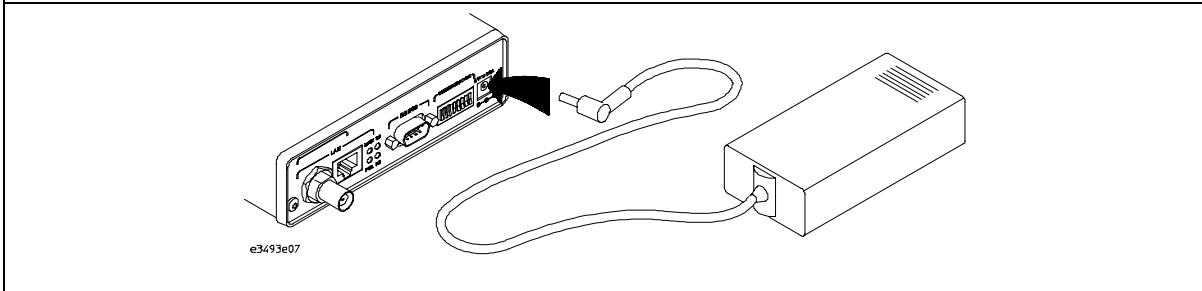

The power light on the target side of the HP processor probe will be illuminated. The HP processor probe does not have an On/Off switch.

Powering up the processor probe

Connecting the Probe to the Prototype Analyzer

The processor probe can be connected directly to the prototype analyzer for a point-to-point connection, or it can be connected via a LAN. The LAN connection allows remote operation; it also allows a probe to be shared by more than one prototype analyzer.

The following sections describe the connections for point-to-point and LAN configurations.

Connecting for a point-to-point configuration

The point-to-point connection is technically a LAN connection, with only two nodes.

- Use the supplied 10Base-T cable (HP part number 5061-7342) to connect the processor probe directly to the prototype analyzer.
- The configuration switches must be set for a LAN configuration. Switch 1 must be set to OPEN, indicating that a LAN connection is being made. Since this is a 10BASE-T connection, switch 5 must also be set to OPEN.
- Use the procedure in "Setting Up LAN Communication" to set the Ethernet address, IP address, and gateway address.

Point-to-point Connection

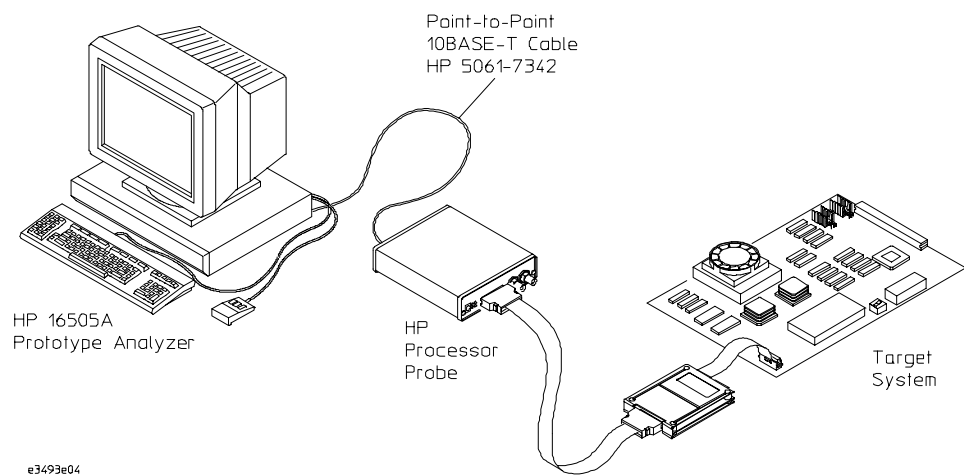

Connecting to a LAN

The HP E3493B Pentium Pro processor probe has two LAN connectors:

- A BNC connector that can be directly connected to an IEEE 802.3 Type 10BASE2 cable (ThinLAN). When using this connector, the processor probe provides the functional equivalent of a Medium Attachment Unit (MAU) for ThinLAN.
- An IEEE 802.3 Type 10BASE-T (StarLAN) connector.

Caution

Use either the 10BASE2 or the 10BASE-T connector. Do *not* use both. The processor probe will not work with both connected at the same time.

The configuration switches must be set for a LAN configuration. Switch 1 must be set to OPEN, indicating that a LAN connection is being made. For 10BASE-T connections, switch 5 must also be set to OPEN. Refer to "To set the 10BASE-T configuration switches" for additional information on configuring 10BASE-T switches.

Use the procedure in "Setting Up LAN Communication" to set the Ethernet address, IP address, and gateway address.

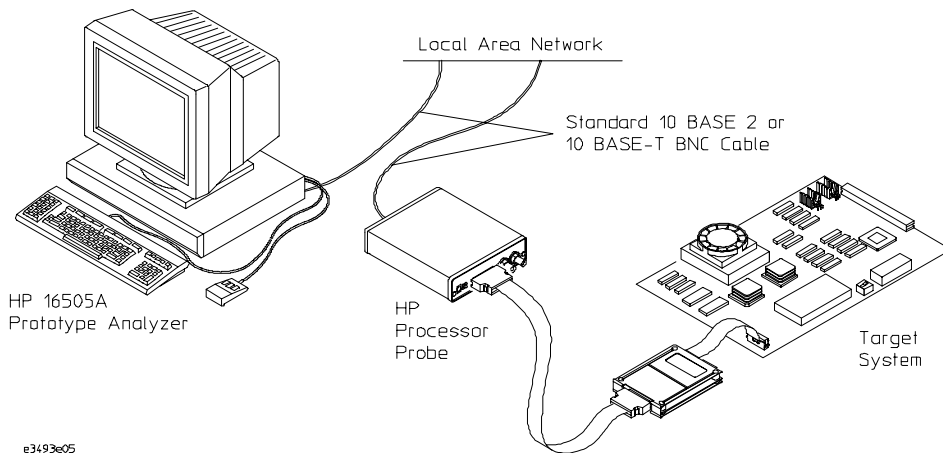

LAN Connection

To set the 10BASE-T configuration switches

Set switches S7 and S8 to CLOSED unless one of the following conditions is true:

- **If the LAN cable exceeds the standard length, set switch S7 to OPEN.**
The processor probe has a switch-selectable, twisted-pair receiver threshold. With switch S7 set to OPEN, the twisted-pair receiver threshold is lowered by 4.5 dB. This should allow you to use cable lengths of up to about 200 meters. If you use a long cable, you should consult with your LAN cabling installer to ensure that:
 - The device at the other end of the cable has long cable capability, and
 - The cable is high-grade, low-crosstalk cable with crosstalk attenuation of greater than 27.5 dB.

When switch S7 is set to CLOSED, the LAN port operates at standard 10BASE-T levels. A maximum of 100 meters of UTP cable can be used.

- **If your network doesn't support Link Beat integrity checking or if the processor probe is connected to a non 10BASE-T network (such as StarLAN) set this switch to LINK BEAT OFF (0 or OPEN).**

In normal mode (switch S8 set to CLOSED), a link integrity pulse is transmitted every 15 milliseconds in the absence of transmitted data. It expects to receive a similar pulse from the remote MAU. This is the standard link integrity test for 10BASE-T networks. If your network doesn't support the Link Beat integrity checking or if the processor probe is used on a non 10BASE-T network (such as StarLAN) set this switch to LINK BEAT OFF (OPEN).

Note

Setting switch S8 to OPEN when Link Beat integrity checking is required by your network will cause the remote MAU to disable communications.

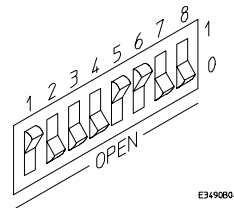
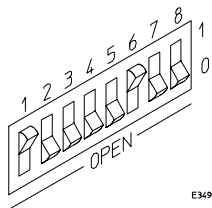

Switch Positions for LAN (left) and 10BASE-T LAN (right) Configurations, S6 Open for Initialization

Setting Up LAN Communication

To initialize the processor probe, you must assign an IP address (Internet address) an Ethernet address, and a gateway address. The IP address and other network parameters are stored in nonvolatile memory within the processor probe. These addresses must be initialized for either point-to-point or LAN connections.

The processor probe must be on the same subnet as the HP 16505A Prototype Analyzer. The processor probe automatically sets the subnet mask based on the subnet mask used by other devices on the network.

To set the LAN address of the processor probe

- Set the configuration switch S6 on the processor probe to OPEN. Cycle power to reconfigure the probe. Switch 6 causes the probe to continuously broadcast a search message over the network.
- Drag the "uP Run Control" tool from the toolbox onto the HP 16505A prototype analyzer workspace.
- Move the mouse cursor over the icon, press the right mouse button, and select "Init Probe LAN Addresses...".
- Enter the Ethernet address, IP address, and the gateway address in the appropriate fields, then select Set Addresses.

Use the processor probe Ethernet address. This address is on a sticker labeled "LLA" (for "link-level address") on the processor probe.

For point-to-point connections, use an IP address that is one greater than or one less than the HP 16505A IP address (for example, the prototype analyzer default address is 192.0.2.231, so use 192.0.2.230 or 192.0.2.232).

For LAN connections, obtain an IP address from your local network administrator or system administrator.

The gateway address is an IP address and is entered in integer dot notation. For point-to-point connections, just leave this field blank. If connections are to be made to workstations on other networks or

subnets, this address must be set to the address of the gateway machine. Obtain that address from your local network administrator or system administrator.

- Set the configuration switch S6 back to 1, then power down the probe. When the probe is powered down and then powered up, it will be configured for the new LAN parameters.

See also

"Setting Up the Processor Probe on Your LAN" in the on-line help for the uP Run Control tool.

To verify LAN communications

Start a user session to verify your processor probe is now active and on the network.

- 1 Drag the uP Control Tool from the toolbox to the workspace.
- 2 Move the mouse cursor over the uP Control Tool in the workspace, press and hold the right mouse button, move the cursor over Start Session..., and release the mouse button.

See also

"Starting Sessions" in the on-line help for the uP Run Control tool.

If You Have Problems

If you encounter problems, refer to the "Problems" chapter (page 37).

Setting Up a Serial Connection

If you are having difficulty establishing LAN connections and need to perform the LAN performance verification tests, you will need a serial connection.

To set up a serial connection, you will need to:

- Set the serial configuration switches
- Connect the HP E3493B Pentium Pro processor probe to the RS-232 interface
- Connect a serial cable between the host computer and the processor probe
- Verify communications

Serial connections on a workstation

If you are using a UNIX workstation as the host computer, you need to use a serial device file. If a serial device file does not already exist on your host, you need to create one. Once it exists, you need to ensure that it has the appropriate permissions so that you can access it. See the system documentation for your workstation for help with setting up a serial device.

Serial connections on a PC

Serial connections are supported on PCs. You must use hardware handshaking if you will use the serial connection for anything other than setting LAN parameters.

If you are using a PC as the host computer, you do not need to set up any special files.

To set the serial configuration switches

- 1 Set switch S1 to CLOSED (RS-232).
- 2 Set switches S2-S4 to CLOSED.
- 3 Set switch S5 to CLOSED (HW HANDSHAKE ON) if your serial interface uses the DSR:CTS/RTS lines for flow control. Set S5 to OPEN (HW HANDSHAKE OFF) if your serial interface uses software flow control (XON/XOFF).

If your serial interface supports hardware handshaking, you should use it (set switch S5 to CLOSED). Hardware handshaking will make the serial connection much more reliable.

- 4 Set switches S6-S8 for the baud rate you will use. These switch settings are listed on the bottom of the processor probe.

The higher baud rates may not work reliably with all hosts and user interfaces. Make sure the baud rate you choose is supported by your host and user interface.

Example

To use a baud rate of 9600 baud, set the switches as follows:

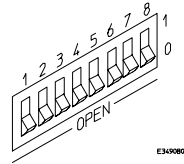

To connect a serial cable

CAUTION

Use a grounded, shielded cable. If the cable is not shielded, or if the cable is not grounded at the serial controller, the processor probe may be damaged by electrostatic discharge.

Connect an RS-232C modem cable from the host computer to the HP E3493B processor probe. The recommended cable is HP part number C2932A. This is a 9-pin cable with one-to-one pin connections.

To verify serial communications

1 Start a terminal emulator program on the host computer.

If you are using a PC, the Terminal application in Microsoft Windows will work fine.

If you are using a UNIX workstation, you can use a terminal emulator such as cu or kermit.

2 Plug the power cord into the processor probe.

When the processor probe powers up, it sends a message (similar to the one that follows) to the serial port and then displays a prompt:

```
Copyright (c) Hewlett-Packard Co. 1987
All Rights Reserved.  Reproduction, adaptation, or translation without prior
written permission is prohibited, except as allowed under copyright laws.
```

```
HPE3499A Series Emulation System
Version:  A.07.01 30Sep96
Location:  Generics
```

```
HPE3493A Pentium(tm) Pro Processor Emulator
Version:  A.01.00 06Nov96
Interface Board: E3493B
```

R>

The version numbers may be different for your processor probe.

3 Press the Return or Enter key a few times.

You should see a prompt such as "R>", "p>", or "?>".

See Also "Problems with the Serial Interface," page 44.

To configure LAN parameters using the built-in terminal interface

This procedure should only be used if you have difficulty establishing LAN communication via the HP 16505A Prototype Analyzer Run Control interface.

- 1 Set configuration switches S1 through S4 to CLOSED, and set the other switches as appropriate for your serial interface.

Switch settings are printed on the bottom of the processor probe. If you will use a baud rate of 9600 baud, set the switches like this:

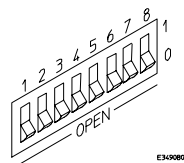

- 2 Connect an ASCII terminal (or terminal emulator) to the processor probe's RS-232 port with a 9-pin RS-232 cable.

Complete instructions for setting up a serial connection begin on page 17.

- 3 Plug in the processor probe's power cord. Press the terminal's <RETURN> key a couple times. You should see a "p>" or "R>" prompt.

At this point, you are communicating with the processor probe's built-in terminal interface.

- 4 Display the current LAN configuration values by entering the **lan** command:

```
R>lan
lan is disabled
lan -i 0.0.0.0
lan -g 0.0.0.0
lan -p 6470
Ethernet Address : 08000903212f
```

The "lan -i" line shows the current IP address (IP address) of the processor probe.

The Ethernet address, also known as the link level address, is preassigned at the factory, and is printed on a label above the LAN connectors.

- 5 Enter the following command:

```
lan -i <internet> [-g <gateway>] [-p <port>]
```

Setting Up a Serial Connection
To configure LAN parameters using the built-in terminal interface

The lan command parameters are:

- i <internet> The IP address which you obtained from your network administrator.
- g <gateway> The gateway address. Setting the gateway address allows access outside your local network or subnet.
- p <port> This changes the base TCP service port number.

The prototype analyzer uses the TCP service port numbers 6470 and 6471. If these numbers are somehow changed in the processor probe, use the -p parameter to change them back to 6470 and 6471.

6 Disconnect the power cord from the processor probe, and connect the the processor probe to your network.

This connection can be made by using either the 10BASE-T connector or the 10BASE2 (BNC) connector on the processor probe. Do not use both connectors at the same time.

7 Set the configuration switches to indicate the type of connection that is to be made.

Switch S1 must be set to OPEN, indicating that a LAN connection is being made.

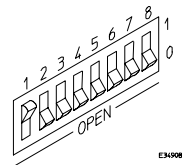

Switch S5 should be 1 if you are connecting to the BNC connector:

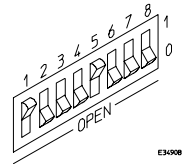

Switch S5 should be 0 if you are connecting to the 10BASE-T connector:
Set all other switches to CLOSED.

- 8 Connect the power cord to the processor probe.**
- 9 Verify your HP E3493B Pentium Pro processor probe is now active and on the network. See "To verify LAN communications" on page 16.**

Setting Up a Serial Connection
To configure LAN parameters using the built-in terminal interface

Once you have set a valid IP address, you can use prototype analyzer to verify LAN communication.

Example

For example, to assign an IP address of 192.6.94.2 to the HP E3493B processor probe, enter the following command:

```
R>lan -i 192.6.94.2
```

The IP address and any other LAN parameters you change are stored in nonvolatile memory and will take effect the next time the HP E3493B processor probe is powered off and back on again.

See Also

"Solving Problems," page 37, if you have problems verifying LAN communication.

Connecting to the Target System

Connecting to a Target System

The E3493B Pentium Pro processor probe can be connected to a target system directly through a debug port connector on the target board.

This chapter describes the procedures to connect to the Intel-defined debug connector.

For a list of the parts supplied with the HP E3493B Pentium Pro processor probe, see page 54.

Designing a target system test access port

For information about incorporating a debug port into your target design, refer to the *Pentium Pro Family Developer's Manual*, Volume 1, chapter 16, "Tools" (Intel order #2426900-001). Other important information can be found in Chapter 11, "Electrical Specifications."

In addition, the following should be considered when designing a target system with a debug port:

- POWERON from the target system (pin 9 of the debug port) should be sourced from the GTL and V_{tt} , not +5 volts.

To test the HP E3493B Pentium Pro processor probe

If this is the first time that you have used the E3493B Pentium Pro processor probe, you should run the built-in performance verification test before you connect to a target system. Refer to chapter 5 for information on performance verification.

To connect to a target system via the debug port

The HP E3493B processor probe should be connected to the target system using the 30-conductor cable assembly provided.

- 1** Remove power from the target system and the probe.
- 2** Plug one end of the 50-pin cable into the E3493B Pentium Pro processor probe.
- 3** Plug the other end of the 50-pin cable into the interface board.
- 4** Plug the 30-pin connector into the connector on the interface board labeled "TARGET".
- 5** Plug the other end of the 30-pin cable into the debug port in the target system.
- 6** Turn on the power to the probe, then turn on the power to the target system.

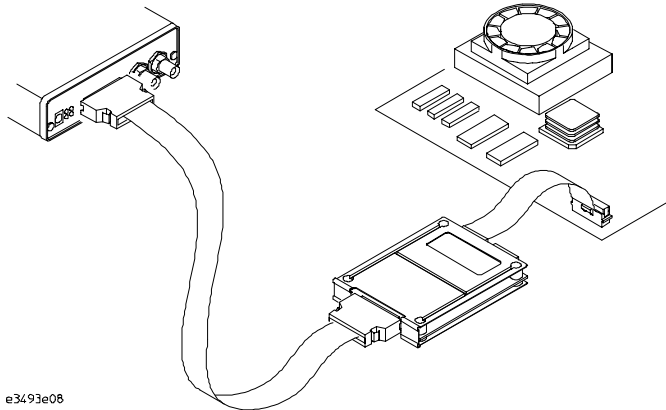

e3493e08

Connecting to the Target System
To connect to a target system via the debug port

Configuring the Processor Probe

Configuring the Processor Probe

You must configure the HP E3493B Pentium Pro processor probe to work with your target system.

The easiest way to configure the processor probe is through the uP Run Control tool in the HP 16505A Prototype Analyzer. Another way is to use the processor probe's built-in terminal interface.

What can be configured

The configurable parameters are:

- The JTAG chain. The JTAG chain must be defined before the processor probe will work with your target system.
- The JTAG frequency.
- The Trigger Out BNC.
- The Trigger In BNC.
- Processor reset behavior.
- Processor initialization behavior.
- Breaks when a debug register is accessed by your program.
- Branch trace messaging.
- Breaks on SMM mode.

To configure using the Run Control tool

If you are using the processor probe with an HP 16505A prototype analyzer, you can use the Run Control tool to configure the processor probe.

1 Start a "uP Run Control" session.

Drag the "uP Run Control" tool from the toolbox onto the HP 16505A prototype analyzer workspace. Next, move the mouse cursor over the icon, press the right mouse button, and select "Start Session...".

2 Open a Configuration window.

Select "Configuration..." from the tool menu or from the Window menu in any uP Run Control tool window.

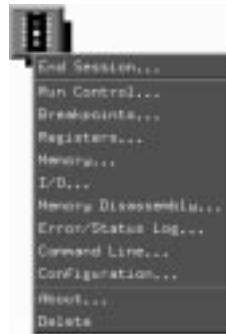

3 Configure the JTAG chain, as described on page 30.

4 Set any of the other options, as needed.

5 Save the configuration settings.

If you like, you can save the configuration settings as part of a workspace.

To save the configuration settings, save the workspace by selecting **File→Save Workspace As...** from the prototype analyzer's main menu.

6 Close the Configuration window.

The configuration selections you have made will take effect when you close the configuration window or when you move the mouse pointer outside the window.

See Also

Help →Help on this window in the Configuration window for information on each of the configuration options.

Help in the Run Control tool menu for help on starting a uP Run Control session.

To configure using the built-in terminal interface

If you are unable to use the Run Control tool, you can configure the processor probe using the built-in terminal interface.

- 1 Connect a terminal or terminal emulator to the processor probe's serial port, or use a telnet session over the LAN.
- 2 Enter "cf" to see the current configuration settings.
- 3 Use the cf command to change the configuration settings.

See Also

Enter "help cf" for help on the configuration commands.

To configure the JTAG scan chain

You must define the order of the processors and other devices on the JTAG chain at the debug port.

If you know the JTAG scan chain for your target system:

- 1 Open the Run Control tool Configuration window.
- 2 Enter the scan chain.

To define the JTAG chain, use the following syntax:

```
{p|<i>ilength</i>}[, {p|<i>ilength</i>}...]  
or  
{p[0-3]|<i>ilength</i>}[, {p[0-3]|<i>ilength</i>}...]
```

p defines a Pentium Pro processor; the first is p0, the second is p1, and so on. The processor number (p0, p1, ...) corresponds to the line on the debug port (PREQx#) that controls the processor.

p[0-3] defines a Pentium Pro processor which uses the specified *preq#* line.

<ilength> defines the JTAG instruction length of a non-Pentium Pro device.

- 3 Press the **Enter** key.
- 4 Change the other configuration options as necessary.

In some systems, it may be easier to enter the JTAG scan chain while the system is powered up and running. After the JTAG scan chain is entered, it is verified. The scan chain can only be verified when the processors are not reset. In some systems the act of identifying the scan chain causes an unacceptable delay and the processors enter monitor and stay there. To

avoid this, let the processors run as you enter the scan chain; then you may reset and run normally.

If you do not know the JTAG scan chain for your target system:

- 1 Open the Run Control tool Command Line window.
- 2 Enter the **gchain** command.
- 3 Read the warnings carefully and decide whether you should actually have the processor probe run the tests to discover the scan chain.

If you move the HP processor probe from one target system to another, be sure to reconfigure the JTAG chain.

To avoid problems, configure the JTAG chain each time you turn on the processor probe. The JTAG chain setting is stored in the HP 16505A prototype analyzer workspace configuration, but may not be correct for your current target system.

See Also

Chapter 16, "Tools," in the Intel *Pentium Pro Family Developer's Manual, Volume 1: Specifications* for information on how the scan chain works.

Help → **Help on this window** in the Configuration window for information on each of the configuration options.

Examples

`p`

This defines a single processor. In the uP Run Control Tool windows, this processor will be identified as processor number "0".

`p,p`

This defines a chain with two processors. The processors are assumed to be connected to the PREQ0# and PREQ1# lines, respectively. In the uP Run Control Tool windows, the processors will be identified as processor "0" and "1".

`p,10,7,7,p,10,p`

This defines a chain with 3 processors and 4 other devices. This assumes that the first processor uses PREQ0#, the second uses PREQ1#, and so on.

Configuring the Processor Probe
To configure the JTAG scan chain

```
p1,10,7,7,p3,10,p0
```

This specifies that the first processor uses PREQ1#, and so on.

Specifications and Characteristics

Processor Compatibility

The HP E3493B Pentium Pro processor probe supports the Pentium Pro microprocessor family. Contact HP for details.

Electrical Specifications

BNC, labeled TRIGGER OUT

Output Drive Logic high level with 50-ohm load ≥ 2.0 V. Logic low level with 50-ohm load ≤ 0.4 V. Output function is selectable by the HP 16505A Prototype Analyzer. Refer to Online Help for more information.

BNC, labeled BREAK IN

Input Edge-triggered TTL level input (active high), 20 pf, with 2K ohms to ground in parallel. Maximum input: 5 V above V_{CC} ; 5 V below ground. Input function is selectable by the HP 16505A Prototype Analyzer. Refer to Online Help for more information.

Communications

Serial Port 9-pin female type "D" subminiature connector. RS-232 DCE to 115.2 kbaud.

10BASE-T LAN Port RJ-45 connector. IEEE 802.3 10BASE-T (StarLAN).

10BASE 2 LAN Port 50-ohm BNC connector. IEEE 802.3 10BASE2 (ThinLAN). When using this connector, the HP E3493B Pentium Pro processor probe provides the functional equivalent of a Medium Attachment Unit (MAU) for ThinLAN.

Accessory Power Out

12 V, 3.0A, center negative

Power Supply

Input 100-240 V, 1.0 A, 50/60 Hz, IEC 320 connector.

Output 12 V, 3.3 A

Maximum Ratings

Characteristics for HP E3493B Pentium Pro processor probe	Notes	Symbol	Min	Max	Unit
Input voltage range		V_{in}	-0.5	5.5	V
Input voltage range (V_{tt})			1.3	1.7	V
GTL signals					
Input High Voltage	1	V_{ih}	$\frac{2}{3}V_{tt} + 0.2$		V
Input Low Voltage	1	V_{il}		$\frac{2}{3}V_{tt} - 0.2$	V
Input High Current	1	I_{ih}		-15	μA
Input Low Current	1	I_{il}		100	μA
3.3 V tolerant signals					
Output High Voltage	2	V_{oh}	2.4	3.3	V
Output Low Voltage	2	V_{ol}		0.5	V
Output High Current	2	I_{oh}	8		mA
Output Low Current	2	I_{ol}	-16		mA

Notes

1 INIT, PRDY, RESET, TDO

2 TCK, TDI, TMS, TRST#, R/S#, DBRESET

Environmental Specifications

Temperature

Operating, 0 to +40 °C (+32 to +104 °F); nonoperating, -40 to +60 °C (-40 to +140 °F).

Altitude

Operating/nonoperating 4600 m (15 000 ft).

Relative Humidity

15% to 95%.

5

Solving Problems

Solving Problems

If you have problems with the HP E3493B Pentium Pro processor probe, your first task is to determine the source of the problem. Problems may originate in any of the following places:

- The HP E3493B Pentium Pro processor probe itself
- The connection between the HP E3493B Pentium Pro processor probe and the target system
- The target system

You can use two means to determine the source of the problem:

- The status lights on the HP E3493B Pentium Pro processor probe
- The HP E3493B Pentium Pro processor probe "performance verification" tests

Status lights

The following illustration shows the status lights on both sides of the HP E3493B Pentium Pro processor probe and what they mean:

Lit when the power supply is properly connected to the HP E3491A

Lit when one or more target processors are running in monitor mode

Lit when one or more target processors are running in normal (user program)

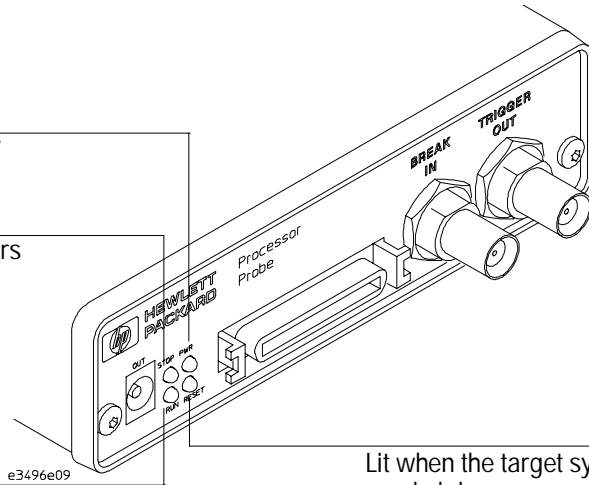

Lit when the target system is in a reset state

Lit when LAN data is being transmitted

Lit when 10BASE-T connection has a good link; not used for 10BASE2

Lit when the polarity on the receive twisted pair is reversed for a 10BASE-T connection

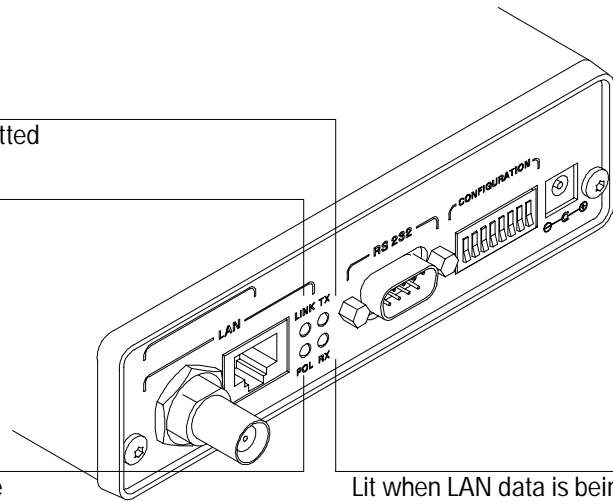

Lit when LAN data is being received

Status Lights

The HP E3493B Pentium Pro processor probe communicates various modes and error conditions via the status lights. The meanings of the status lights are shown on the previous page.

The following table gives more information about the meaning of the power and target status lights.

○ = LED is off

● = LED is on

* = Not applicable (LED is off or on)

Power/Target Status Lights

Pwr/Target LEDs	Meaning
○○	HP E3493B Pentium Pro processor probe is not connected to power supply
○○	
●●	The HP E3493B Pentium Pro processor probe is not connected to the target system, or the JTAG scan chain has not been configured
○○	
○●	Target system is in a reset state, or no target system power
○●	
●●	At least one processor is in the monitor <i>and</i> at least one processor is running user code, or only boot firmware is good (other firmware has been corrupted)
●○	
●●	At least one of the target processors are executing in Debug Mode
○○	
○●	At least one of the target processors are executing user code
●○	

Problems with the LAN Interface

If you cannot verify LAN communication

If you cannot verify connection using the procedure in "To verify LAN communication", or if the commands are not accepted by the processor probe:

- Make sure that you have connected the HP E3493B Pentium Pro processor probe to the proper power source and that the power light is lit.
- Make sure that the LAN cable is connected. Refer to your LAN documentation for testing connectivity.
- Make sure that only one of the LAN ports is connected.
- Make sure the HP E3493B Pentium Pro processor probe communication configuration switches are set correctly. Unplug the HP E3493B processor probe power cord, then plug it in again to make sure the switch settings are read correctly by the HP E3493B Pentium Pro processor probe.
- Make sure that the HP E3493B Pentium Pro processor probe's IP address is set up correctly. Use the RS-232 port to verify this that the IP address is set up correctly. When you are connected to the RS-232 port, run performance verification on the HP E3493B Pentium Pro processor probe's LAN interface with the "pv" command.
- It's also possible for there to be a problem with the HP E3493B Pentium Pro processor probe firmware while the LAN interface is still up and

running. In this case, you must reboot the processor probe by disconnecting power to the processor probe and reconnecting it again.

If you have LAN connection problems

- If the processor probe does not accept commands from the prototype analyzer:
 1. Check that switch S1 is "0" (attached to LAN, not RS-232).
 2. Check that switch S5 is in the correct position for your LAN interface (either 10BASE2 or 10BASE-T).(Remember: if you change any switch settings, the changes do not take effect until you cycle power.)
- If the HP E3493B Pentium Pro processor probe still does not respond, you need to verify the IP address and gateway mask of the HP E3493B processor probe. To do this, connect the HP E3493B Pentium Pro processor probe to a terminal or terminal emulator (see page 17), change the switch settings so it is connected to RS-232, and enter the "lan" command. The output looks something like this:

```
lan -i 15.5.24.116
lan -g 15.5.23.1
lan -p 6470
Ethernet Address : 08000909BAC1
```

"lan -i" shows the internet address is 15.5.24.116 in this case. If the Internet address (IP) is not what you expect, you can change it with the 'lan -i <new IP>' command.

"lan -g" shows the gateway address. Make sure it is the address of your gateway if you are connecting from another subnet, 0.0.0.0 if you are connecting from the local subnet.

"lan -p" shows the port is 6470. If the port is not 6470, you must change it with the "lan -p 6470" command (unless you have deliberately set the port number to a different value because of a conflict).

If the "POL" LED is lit

The "POL" LED indicates that the polarity is reversed on the receive pair if you are using a 10BASE-T connection. The processor probe should still work properly in this situation, but other LAN devices may not work.

If it takes a long time to connect to the network

- Check the subnet masks on the other LAN devices connected to your network. All of the devices should be configured to use the same subnet mask.

Subnet mask error messages do not indicate a major problem. You can continue using the processor probe.

The processor probe automatically sets its subnet mask based on the first subnet mask it detects on the network. If it then detects other subnet masks, it will generate error messages.

If there are many subnet masks in use on the local subnet, the processor probe may take a very long time to connect to the network after it is turned on.

To "clean up" the network, connect a terminal to the processor probe. You can then see error messages which will help you identify which devices on the network are using the wrong subnet masks.

Problems with the Serial Interface

If you cannot verify RS-232 communication

If the HP E3493B Pentium Pro processor probe prompt does not appear in the terminal emulator window:

- Make sure that you have connected the processor probe to the proper power source and that the power light is lit.
- Make sure that you have properly configured the data communications switches on the processor probe and the data communications parameters on the host computer. You should also verify that you are using the correct cable.

The most common type of data communications configuration problem involves the configuration of the processor probe as a DTE device instead of as a DCE device. If you are using the wrong type of cable, no prompt will be displayed.

A cable with one-to-one connections will work with a PC or an HP Series 700 workstation.

If you have RS-232 connection problems with the MS Windows Terminal program

- Remember that Windows 3.1 only allows two active RS-232 connections at a time. To be warned when you violate this restriction, choose Always Warn in the Device Contention group box under 386 Enhanced in the Control Panel.
 - Use the "Terminal" program (usually found in the Accessories windows program group) and set up the "Communications..." settings as follows:
-

If you have RS-232 connection problems with the MS Windows Terminal program

Baud Rate: 9600 (or whatever you have chosen for the emulator)
Data Bits: 8
Parity: None
Flow Control: hardware
Stop Bits: 1

When you are connected, hit the Enter key. You should get a prompt back. If nothing echos back, check the switch settings on the HP E3493B Pentium Pro processor probe.

- If the switches are in the correct position and you still do not get a prompt when you hit return, try turning OFF the power to the HP E3493B Pentium Pro processor probe and turning it ON again.
- If you still don't get a prompt, make sure the RS-232 cable is connected to the correct port on your PC, and that the cable is appropriate for connecting the PC to a DCE device.

With certain RS-232 cards, connecting to an RS-232 port where the HP E3493B Pentium Pro processor probe is turned OFF (or is not connected) will hang the PC. The only way to get control back is to reboot the PC. Therefore, we recommend that you always turn ON the HP E3493B Pentium Pro processor probe before attempting to connect via RS-232.

Problems with the HP E3493B Pentium Pro Processor Probe Itself

To run the power up self test

- 1 Unplug the HP E3493B Pentium Pro processor probe, then plug it in.
- 2 Watch the status lights. They should show the following pattern:
 - = LED is off
 - = LED is on
 - * = Not applicable (LED is off or on)

Normal sequence during power up self test

	Pwr/Target LEDs	Meaning
1	○● ○○	Initial power up, system reset
2	○● ○○	XILINX array initialized successfully
3	○● ●○	XILINX array tested successfully
4	●● ○○	BOOT ROM space tested successfully
5	○● ●○	GENERIC ROM space tested successfully
6	●● ○○	DRIVER ROM space tested successfully
7	○● ●○	RESERVED ROM space tested successfully
8	●● ○○	RAM tested successfully

	Pwr/Target LEDs	Meaning
9	○● ●○	LAN internal feedback tested successfully
10	○● ○○	Boundary scan master (BSM) test begun
11	●● ●○	BSM test completed, start system, load drivers, initialize LAN

If the power up self test fails, the RESET LED will flash the number of the test, then stay lit.

If any of the LEDs fail to change, or all of them remain on, there is a system failure.

Following power up, the LEDs will enter one of the following states:

○●	No target system power, or HP E3493B Pentium Pro processor probe is not connected to the target system, or
○○	
○●	Target system is in a reset state
○○	
●●	Only the boot ROM was used; other firmware in the Flash EPROM has been corrupted
●○	

Starting a user interface will change the pattern to the one requested by the interface.

If the power up self tests fail, try the following:

- Check and reset the LAN address as shown in the "Connecting to the HP 16505A Prototype Analyzer" chapter. LAN powerup failures will occur if the processor probe does not have a valid Link Level Address and IP Address.
- Disconnect all external connections, including the LAN, serial (RS-232), and BNC Break and Trigger cables, then cycle power.
- To ensure that the firmware is working as it should, reprogram the firmware, then cycle power.

To execute the built-in performance verification tests

In addition to the powerup tests, there are several additional performance verification (PV) tests available. Some of these tests can be performed through the prototype analyzer. The LAN tests can only be executed through the RS-232 port.

To perform the PV tests through the prototype analyzer

- 1 End any Run Control tool sessions.
- 2 Disconnect the 30-pin cable from the target system, and plug it into the connector labeled "LOOPBACK" on the adapter board. If you wish to test the BNC, connect a cable between the Break In and Trigger Out connectors.
- 3 From the Run Control tool menu, open the Performance Verification window.
- 4 Enter the LAN address of the processor probe.
- 5 Select "Processor Probe (System Tests)" then click **Start PV**.
- 6 Select "Run Control Probe (Probe Tests)" then click **Start PV**.

Additional PV Tests

The LAN tests can only be executed through the RS-232 port. The remainder of this section assumes that the tests are being run from a terminal emulator connected to the RS-232 port.

For the BREAK IN, TRIGGER OUT BNC FEEDBACK TEST and BNC TEST, connect a coaxial cable between BREAK IN and TRIGGER OUT. For the TARGET PROBE FEEDBACK TEST, connect the self-test board (HP part number E3496-66502).

For the other tests, connect the 30-pin cable between the TARGET and FEEDBACK connectors on the adapter board.

- 1 **Set all of the switches to OPEN.**
This is standard RS-232 at 9600 baud which can be connected directly to a 9 pin RS-232 interface that conforms to the IBM PC-AT 9 pin standard.
- 2 **Use a terminal emulator to connect to the HP E3493B processor probe.**
- 3 **Enter the `pv` command.**
Options available for the "pv" are explained in the help screen displayed by typing "help pv" or "? pv" at the prompt.

Examples:

To execute the tests one time:

```
pv 1
```

To execute test 2 with maximum debug output repeatedly until a ^C is entered:

```
pv -t2 -v9 0
```

To execute tests 3, 4, and 5 only for 2 cycles:

```
pv -t3-5 2
```

On a good system, when the feedback connector is plugged into the target connector, the RESET LED will light and the BKG and USER LEDs will be out.

The results on a good system, with the BNC's connected, and with the target cable plugged into the LOOPBACK connector, are as follows:

```
?>pv 1
```

```
Testing: HPE3499A Series Emulation System
  Test 1: Powerup PV Results           Passed!
  Test 2: LAN 10Base2 Feedback Test    Not Executed!
  Test 3: LAN 10BaseT Feedback Test    Not Executed!
  Test 4: Break In and Trigger Out BNC Feedback Test Passed!
  Test 5: Target Probe Feedback Test   Not Executed!
  Test 6: Boundary Scan Master Test    Not Executed!
  Test 7: I2C Test                     Not Executed!
Testing: HPE3493B Pentium(tm) Pro Processor Emulator
  Test 1: Xilinx internal              Passed!
  Test 2: Loopback test                Passed!
  Test 3: BSM test                    Passed!
  Test 4: Group breaks                 Passed!
  Test 5: Break on reset               Passed!
  Test 6: BNC test                    Passed!
  Test 7: Power Poll                  Passed!
PASSED Number of tests: 1              Number of failures: 0
```

Copyright (c) Hewlett-Packard Co. 1987
All Rights Reserved. Reproduction, adaptation, or translation without prior written permission is prohibited, except as allowed under copyright laws.

```
HPE3499B Series Emulation System
  Version:  A.07.02 07Nov96
  Location:  Generics
Probe ID is 0x12
```

Solving Problems
To execute the built-in performance verification tests

HPE3493B Pentium(tm) Pro Processor Emulator
Version: A.01.00 08Nov96 13:09

?>

There are some things you can do if a failure is found on one of these tests. Details of Failure can be obtained through using a verbose level of 2 or more. If the particular failure you see is not listed below, contact HP for assistance.

TEST 2: LAN 10BASE2 Feedback Test failed

For LAN 10BASE2 test, the following is an example of a failure which is *not* caused by a broken HP E3493B Pentium Pro processor probe.

R>pv -t2 -v2 1

```
Testing: HPE3499A Series Emulation System
Test # 2: LAN 10Base2 Feedback Test                failed!
      FAILED - no lan connection (LAN probably not terminated)
FAILED Number of tests: 1                Number of failures: 1
```

Check to see that the port under test has a good cable connected to it and that the cable is properly terminated with a 50 ohm terminator on each end of the overall cable.

R>pv -t2 -v2 1

```
Testing: HPE3499A Series Emulation System
Test # 2: LAN 10Base2 Feedback Test                failed!
      FAILED due to excessive collisions
FAILED Number of tests: 1                Number of failures: 1
```

The most common cause of this problem is poor termination of the cable or failure to remove the port under test from the LAN before performing the test. Check to see that the terminators are good (50 Ohms) and that you are isolated from any traffic on a system LAN.

R>pv -t2 -v2 1

```
Testing: HPE3499A Series Emulation System
Test # 2: LAN 10Base2 Feedback Test                failed!
      FAILED - invalid Ethernet address in EEPROM
FAILED Number of tests: 1                Number of failures: 1
```

First check to see that a correct LLA and IP address have been set in the virtual EEPROM through the "lan" command. If the "lan" command shows bad information for the LLA and IP, then try to set them to correct values. If you are unable to set them to correct values, there is a failure in the FLASH ROM which requires service from HP.

Test 3: 10BaseT Feedback Test failed

```
R>pv -t3 -v2 1
```

```
Testing: HPE3499A Series Emulation System
  Test # 3: LAN 10BaseT Feedback Test          passed!
PASSED  Number of tests: 1                    Number of failures: 0
```

In addition to the internal checks performed in Test 2, this test also checks for shorts on the cable connected to the network. If this test fails, disconnect the cable and run the test again. If it then passes, the cable is faulty. If it still fails, it requires service from HP.

If the HP E3493B Pentium Pro processor probe passes this "pv" test, additional testing can be performed through exercising the connection to the network. To run this test, set configuration switch 1 and switch 5 to OPEN, all other configuration switches CLOSED (this enables LAN using 10BaseT). Cycle power and wait for 15 to 30 seconds. Then "ping" the HP E3493B Pentium Pro processor probe from your host computer or PC. See the LAN documentation for your host computer for the location and action of the "ping" utility. If the HP E3493B Pentium Pro processor probe fails to respond to the "ping" request, verify that the lan parameters (IP address and gateway address) are set correctly and that your host computer recognizes the IP address of the HP E3493B Pentium Pro processor probe. If all else is good, then failure to respond to ping indicates a faulty HP E3493B Pentium Pro processor probe.

HPE3499A TEST 4: Break In and Trigger Out BNC Feedback Test or HPE3493B TEST 6: BNC Test failed

```
R>pv -t4 -v2 1
```

```
Testing: HPE3499A Series Emulation System
  Test # 4: Break In and Trigger Out BNC Feedback Test  failed!
  Break In not receiving Break Out HIGH
FAILED  Number of tests: 1                    Number of failures: 1
```

Before returning to HP, check to ensure that you have connected a good coaxial cable between the two BNCs. If the cable is good, the E3493B is bad.

TEST 5: Target Probe Feedback Test failed

Solving Problems To execute the built-in performance verification tests

A verbose output on this test can be extensive. For example, the following is the output of this test if you forget to plug in the self-test board.

```
p>pv -t5 -v2 1
```

```
Testing: HPE3499A Series Emulation System
Test # 5: Target Probe Feedback Test                                failed!
  Bad 20 Pin Status Read when unconnected = 0x7fb7
                                     Expected Value = 0xffb7
  Bad 20 Pin Status Read when connected= 7fb7
                                     Expected Value = 0x7fb7
  Output 19 Low not received on Input 11
  Output 11 Low not received on Input 19
  Output 13 Low not received on Input 1
  Output 12 High not received on Input 6
  Output 12 and Input 6 not pulled high on release
  Output 8 Low not received on Input 10
  Output 7 Low not received on Input 20
  Output 4 Low not received on Input 14
  Output 2 Low not received on Input 18
FAILED Number of tests: 1          Number of failures: 1
```

If the you get a verbose output like this, check to make sure that the self test loopback connector was connected properly.

All HPE3493B tests not executed

```
?pv -d 1
```

```
Testing: HPE3493B Pentium(tm) Pro Processor Emulator
Test 1: Xilinx internal                                           Not Executed!
Test 2: Loopback test                                             Not Executed!
Test 3: BSM test                                                  Not Executed!
Test 4: Group breaks                                              Not Executed!
Test 5: Break on reset                                            Not Executed!
Test 6: BNC test                                                  Not Executed!
Test 7: Power Poll                                               Not Executed!
PASSED Number of tests: 1          Number of failures: 0
```

These tests will not be executed if the adapter board (target interface module) is not connected. If the adapter board is connected, the processor probe's I2C logic (which drives the signals to your target system) may have failed.

Returning the HP E3493B Pentium Pro Processor Probe to Hewlett-Packard for Service

To return the HP E3493B Pentium Pro processor probe to Hewlett-Packard

- 1** Follow the procedures in this chapter to make sure that the problem is caused by a failure in the HP E3493B Pentium Pro processor probe or power supply, not by configuration or communication problems.
- 2** Call your nearest HP sales office. Ask them for the address of the nearest HP service center.

A list of HP sales offices is included at the back of this binder.

- 3** Package the HP E3493B Pentium Pro processor probe or the power supply and send it to the HP service center.

If only the HP E3493B Pentium Pro processor probe is broken, keep the power supply and cables. If only the power supply is broken, keep the HP E3493B processor probe and cables.

- 4** When the HP E3493B Pentium Pro processor probe or the power supply has been replaced, it will be sent back to you.

The unit returned to you will have the same serial number as the unit you sent to HP.

To obtain replacement parts

- Order one of the following parts from your HP sales office:

Part numbers

Exchange Assemblies

Part Number	Description
E3493-69401	Replacement Probe Sub-Assembly-Programmed

Replacement Assemblies

Part number	Description
0950-3043	Power Supply
E3493-61601	30-conductor cable assembly
E3496-61601	50-conductor cable assembly
E3496-66502	self-test board
E3493-66501	adapter board ("target interface module")

Index

A

altitude specifications, 36
AUI connector on LAN interface, 13

B

BKG light, 39
BNC, LAN, 13, 34

C

cable
 LAN, 14
 power, 10
 replacing, 54
 serial, 18
clocks
 specifications, 34–35
configuration, 27, 29–32
connecting to the host workstation, 7
connecting to the target system, 23–26
connection problems, LAN, 42
connection problems, RS-232, 44–45
connector
 10BASE-T, 34
 10BASE2, 34
 serial, 34

D

data communications
 specifications, 34
DCE or DTE selection and RS-232 cable, 44

E

ethernet address, 20

G

gateway, 42
gateway address, 21

H

HP 64700 LAN port number, 42
HP 64700 switch settings, LAN, 42
HP 64700 switch settings, RS-232, 44–45

I

IEEE 802.3, 15–16
IP address, 15, 21, 41–42

J

JTAG, scan chain, 30–32

L

LAN connection problems, 42, 50–51
LAN interface, 15–16
LAN parameters, configuring, 15
 terminal interface, 20–22
lights
 See status lights
link beat, 14
link level address, 20
LINK light, 39

M

mask, subnet, 43
MAU, 13, 34

P

performance verification test, 48–52
ping command, 42
POL light, 39, 43
port number, 21
power cord, 9–10
power up self test, 46–47
probe, testing, 51
pv command, 48–52

R

RESET light, 39
restriction on number of RS-232
connections, 44–45
RS-232
 See serial connection

S

scan chain, 30–32
self test, 46–47
serial connection
 DCE or DTE selection, 44
 number of connections, 44–45
 problems, 44–45
 setting up, 17–22
 verifying, 19
service ports, TCP, 21
service, how to obtain, 53
setup
 See configuration

specifications

altitude, 36
clock, 34–35
data communications, 34
temperature, 36
trigger in/out, 34
StarLAN, 13–14
status lights, 40, 46–47
subnet mask, 15, 42–43
switches
 serial configuration, 18

T

TAP (test access port), 24
target system
 connecting to, 24
telnet, 41
temperature specifications, 36
terminal (MS Windows program), 44–45
terminal interface
 LAN parameters, setting, 20–22
test access port, 24
ThinLAN, 13, 34
trigger
 in/out specifications, 34
turning on power, 10
TX light, 39

U

USER light, 39

DECLARATION OF CONFORMITY

according to ISO/IEC Guide 22 and EN 45014

Manufacturer's Name: Hewlett-Packard Company

Manufacturer's Address: Colorado Springs Division
1900 Garden of the Gods Road
Colorado Springs, CO 80907 U.S.A.

declares, that the product

Product Name: Processor Probe

Model Number(s): HP E3493A/B

Product Option(s): All

conforms to the following Product Specifications:

Safety: IEC 1010-1:1990+A1 / EN 61010-1:1993
UL 3111
CSA-C22.2 No. 1010.1:1993

EMC: CISPR 11:1990 / EN 55011:1991 Group 1 Class A
IEC 555-2:1982 + A1:1985 / EN 60555-2:1987
IEC 555-3:1982 + A1:1990 / EN 60555-3:1987 + A1:1991
IEC 801-2:1991 / EN 50082-1:1992 4 kV CD, 8 kV AD
IEC 801-3:1984 / EN 50082-1:1992 3 V/m {1kHz 80% AM, 27-1000 MHz}
IEC 801-4:1988 / EN 50082-1:1992 0.5 kV Sig. Lines, 1 kV Power Lines

Supplementary Information:

The product herewith complies with the requirements of the Low Voltage Directive 73/23/EEC and the EMC Directive 89/336/EEC, and as marked accordingly.
This product was tested in a typical configuration with Hewlett-Packard test systems.

Colorado Springs, 9/17/96

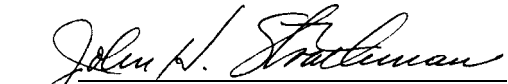
John Strathman, Quality Manager

European Contact: Your local Hewlett-Packard Sales and Service Office or Hewlett-Packard GmbH, Department ZQ / Standards Europe, Herrenberger Strasse 130, D-71034 Böblingen Germany (FAX: +49-7031-14-3143)

Product Regulations

Safety IEC 1010-1: 1990+A1 / EN 61010-1: 1993
UL 3111
CSA-C22.2 No.1010.1:1993

EMC This product meets the requirement of the European Communities (EC)
EMC Directive 89/336/EEC.



Emissions EN55011/CISPR 11 (ISM, Group 1, Class A equipment)



Immunity		Code ¹	Notes ²
EN50082-1			
IEC 555-2		1	
IEC 555-3		1	
IEC 801-2 (ESD) 8kV AD		1	1,,2
IEC 801-3 (Rad.) 3 V/m		2	2
IEC 801-4 (EFT) 1kV		1	

¹ Performance Codes:

- 1 PASS - Normal operation, no effect.
 - 2 PASS - Temporary degradation, self recoverable.
 - 3 PASS - Temporary degradation, operator intervention required.
 - 4 FAIL - Not recoverable, component damage.
-

² Notes:

- 1. The run control probe and cable assembly are sensitive to ESD events. Use Standard ESD preventative practices to avoid damage.
- 2. The 10 Base-T and 10Base-2 cables were disconnected.

Sound Pressure Level NA

© Copyright Hewlett-Packard Company 1994, 1997
All Rights Reserved.

Reproduction, adaptation, or translation without prior written permission is prohibited, except as allowed under the copyright laws.

Restricted Rights Legend

Use, duplication, or disclosure by the U.S. Government is subject to restrictions set forth in subparagraph (C) (1) (ii) of the Rights in Technical Data and Computer Software Clause in DFARS 252.227-7013.

Hewlett-Packard Company, 3000 Hanover Street, Palo Alto, CA 94304 U.S.A. Rights for non-DOD U.S. Government Departments and Agencies are set forth in FAR 52.227-19(c)(1,2).

Document Warranty

The information contained in this document is subject to change without notice.

Hewlett-Packard makes no warranty of any kind with regard to this material, including, but not limited to, the implied warranties of merchantability or fitness for a particular purpose.

Hewlett-Packard shall not be liable for errors contained herein or for damages in connection with the furnishing, performance, or use of this material.

Safety

This apparatus has been designed and tested in accordance with IEC Publication 1010, Safety Requirements for Measuring Apparatus, and has been supplied in a safe condition. This is a Safety Class I instrument (provided with terminal for protective earthing). Before applying power, verify that the correct safety precautions are taken (see the following warnings). In addition, note the external markings on the instrument that are described under "Safety Symbols."

Warning

- Before turning on the instrument, you must connect the protective earth terminal of the instrument to the protective conductor of the (mains) power cord. The mains plug shall only be inserted in a socket outlet provided with a protective earth contact. You must not negate the protective action by using an extension cord (power cable) without a protective conductor (grounding). Grounding one conductor of a two-conductor outlet is not sufficient protection.
- Only fuses with the required rated current, voltage, and specified type (normal blow, time delay, etc.) should be used. Do not use repaired fuses or short-circuited fuseholders. To do so could cause a shock or fire hazard.

- Service instructions are for trained service personnel. To avoid dangerous electric shock, do not perform any service unless qualified to do so. Do not attempt internal service or adjustment unless another person, capable of rendering first aid and resuscitation, is present.
- If you energize this instrument by an auto transformer (for voltage reduction), make sure the common terminal is connected to the earth terminal of the power source.
- Whenever it is likely that the ground protection is impaired, you must make the instrument inoperative and secure it against any unintended operation.
- Do not operate the instrument in the presence of flammable gasses or fumes. Operation of any electrical instrument in such an environment constitutes a definite safety hazard.
- Do not install substitute parts or perform any unauthorized modification to the instrument.
- Capacitors inside the instrument may retain a charge even if the instrument is disconnected from its source of supply.

Safety Symbols



Instruction manual symbol: the product is marked with this symbol when it is necessary for you to refer to the instruction manual in order to protect against damage to the product.



Hazardous voltage symbol.



Earth terminal symbol: Used to indicate a circuit common connected to grounded chassis.

WARNING

The Warning sign denotes a hazard. It calls attention to a procedure, practice, or the like, which, if not correctly performed or adhered to, could result in personal injury. Do not proceed beyond a Warning sign until the indicated conditions are fully understood and met.

CAUTION

The Caution sign denotes a hazard. It calls attention to an operating procedure, practice, or the like, which, if not correctly performed or adhered to, could result in damage to or destruction of part or all of the product. Do not proceed beyond a Caution symbol until the indicated conditions are fully understood or met.

Product Warranty

This Hewlett-Packard product has a warranty against defects in material and workmanship for a period of one year from date of shipment. During the warranty period, Hewlett-Packard Company will, at its option, either repair or replace products that prove to be defective. For warranty service or repair, this product must be returned to a service facility designated by Hewlett-Packard.

For products returned to Hewlett-Packard for warranty service, the Buyer shall prepay shipping charges to Hewlett-Packard and Hewlett-Packard shall pay shipping charges to return the product to the Buyer. However, the Buyer shall pay all shipping charges, duties, and taxes for products returned to Hewlett-Packard from another country.

Hewlett-Packard warrants that its software and firmware designated by Hewlett-Packard for use with an instrument will execute its programming instructions when properly installed on that instrument. Hewlett-Packard does not warrant that the operation of the instrument software, or firmware will be uninterrupted or error free.

Limitation of Warranty

The foregoing warranty shall not apply to defects resulting from improper or inadequate maintenance by the Buyer, Buyer-supplied software or interfacing, unauthorized modification or misuse, operation outside of the environmental specifications for the product, or improper site preparation or maintenance.

No other warranty is expressed or implied. Hewlett-Packard specifically disclaims the implied warranties of merchantability or fitness for a particular purpose.

Exclusive Remedies

The remedies provided herein are the buyer's sole and exclusive remedies. Hewlett-Packard shall not be liable for any direct, indirect, special, incidental, or consequential damages, whether based on contract, tort, or any other legal theory.

Assistance

Product maintenance agreements and other customer assistance agreements are available for Hewlett-Packard products.

For any assistance, contact your nearest Hewlett-Packard Sales Office.

Certification

Hewlett-Packard Company certifies that this product met its published specifications at the time of shipment from the factory. Hewlett-Packard further certifies that its calibration measurements are traceable to the United States National Institute of Standards and Technology, to the extent allowed by the Institute's calibration facility, and to the calibration facilities of other International Standards Organization members.

About this edition

This is the second edition of the *HP processor probe Installation and Service Guide*.

Publication number
E3493-97001, December 1997
Printed in USA.

Edition dates are as follows:
E3493-97000 January 1997

New editions are complete revisions of the manual. Many product updates do not require manual changes, and manual corrections may be done without accompanying product changes. Therefore, do not expect a one-to-one correspondence between product updates and manual updates.

Pentium is a U.S. registered trademark of Intel Corporation.

UNIX is a registered trademark in the United States and other countries, licensed exclusively through X/Open Company Limited.